



Technical Bulletin (TB-0071-04)

ESC201 to SE-i1 Electronic Module

September 2020

ESC201 to SE-i1 Field Conversion Guidelines

This document serves as a guideline for replacing the ESC201 to the SE-i1 module and includes detailed modifications required to complete this upgrade. The ESC201 controller will be discontinued on January 1st, 2020.

For more information on the SE-i1, refer to documents CT-110 Technical Information and CG-110 Reference Guide.

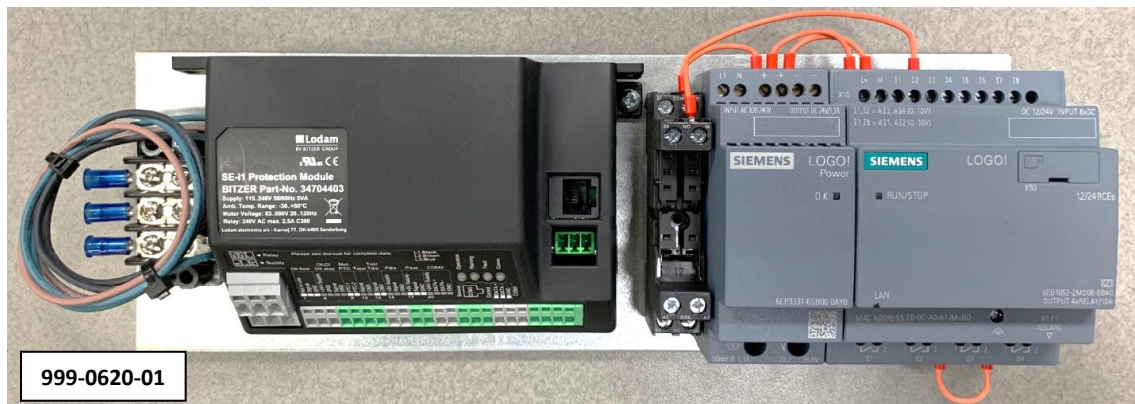

BEST Tool and the BEST Software:

- Required for configuration.
 - Best Tool part number: 344314-02.
 - Best Software: https://www.bitzer.de/shared_media/files/BEST-2.11.55.0.exe

Key Points:

- Install the proper relay (provided) 110 or 220 volt into the relay socket.



- Replace the existing PTC100 or PT1000 discharge temperature sensor with the NTC sensor provided in the kit.
- Label all wiring prior to removal. Some existing wires will not be used on the SE-i1 module and must be capped.
- The existing 24-volt power supply transformer will not be used on the SE-i1 module.
- Do not remove the existing snap track from the panel. The SE-i1 and components are pre-mounted on a back plate which will fit into the existing snap track.

SE-i1 Wiring:

ESC201	Description	SE-i1
A5	Digital Oil Flow Input	#2
A7	Digital Common Ground	#3
B1	Motor Overload Input	#8
B7	Analog Input Ground	#9
C1	Compressor Control Input	C
C5	Compressor Output	NO
C10	Alarm Output	NC
C12	Control & Alarm Input	L
A	Phase Input	L1
B	Phase Input	L2
C	Phase Input	L3

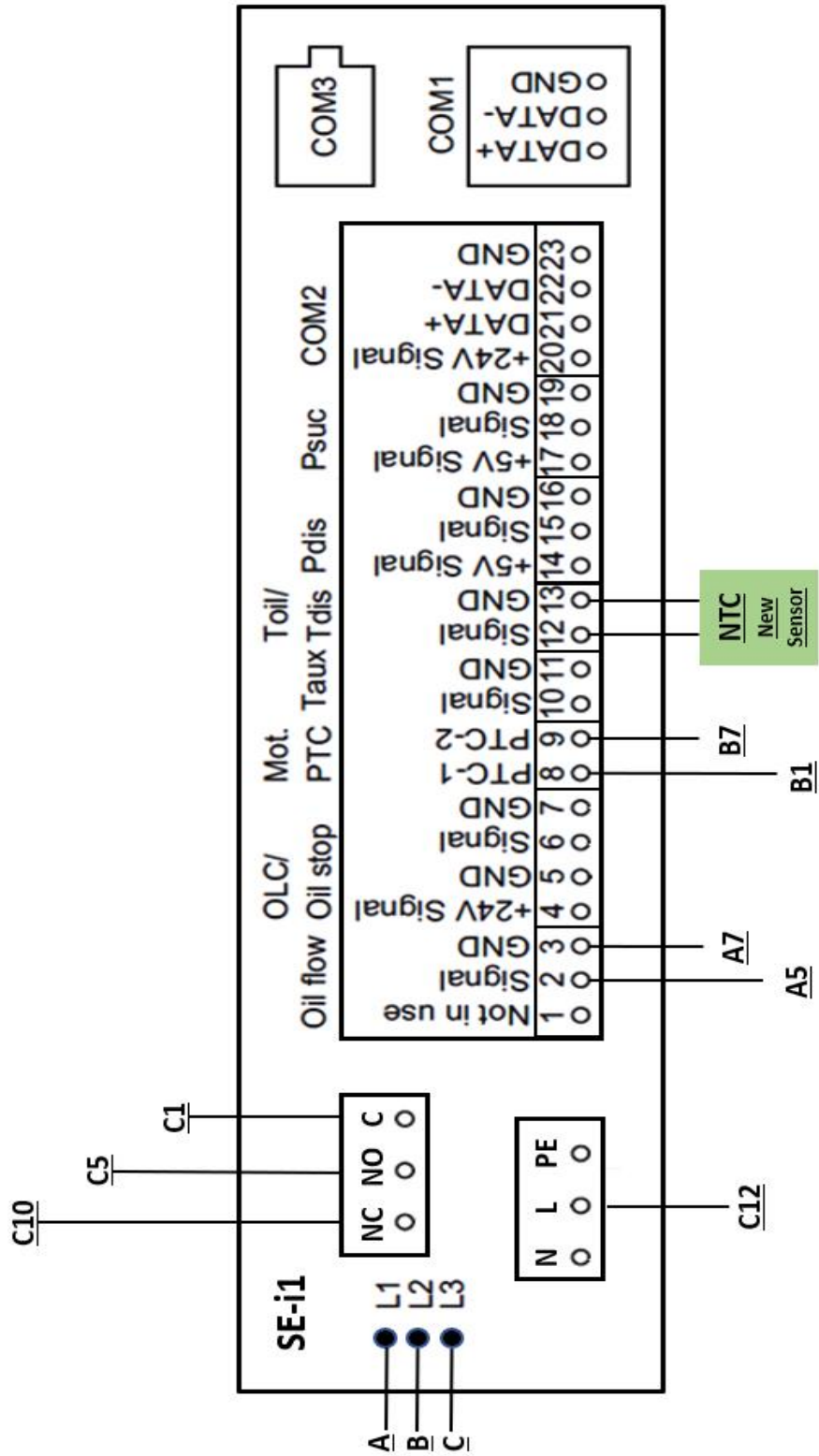

Name	Logo Input ID	Logo Output ID	Time Delay	Note
Run Proof	I3	Close Q1	7 sec	CR1
		Close Q2	7 sec	CR2
		Close Q3	0.5 sec	PW Contactor
		Close Q4	2 sec	Oil & Eco Solenoid
		Open Q1-Q4	1 sec	After loss of signal to I3

LEGEND



ESC201	Description	Logo
C2	Loader #1 Input	Q1-1
C3	Loader #2 Input	Q2-1
C6	Part Winding Output	Q3-2
C7	Loader #1 Output	Q1-2
C8	Loader #2 Output	Q2-2
C9	Compressor Control Input	Q4-2
C11	Economizer Output	Q4-2
C12	Control and Alarm Input	Q3-1

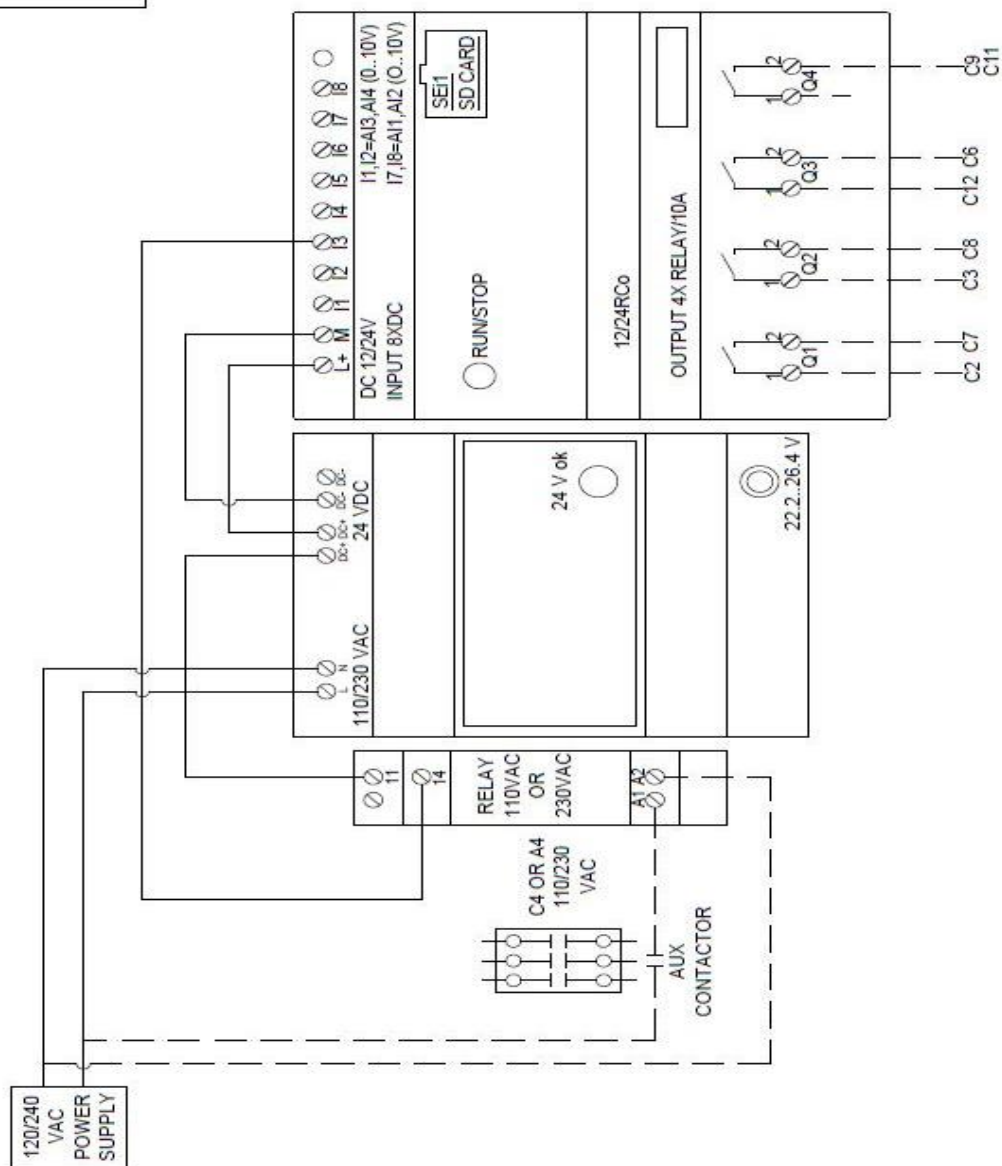

Existing ESC201 Wiring:

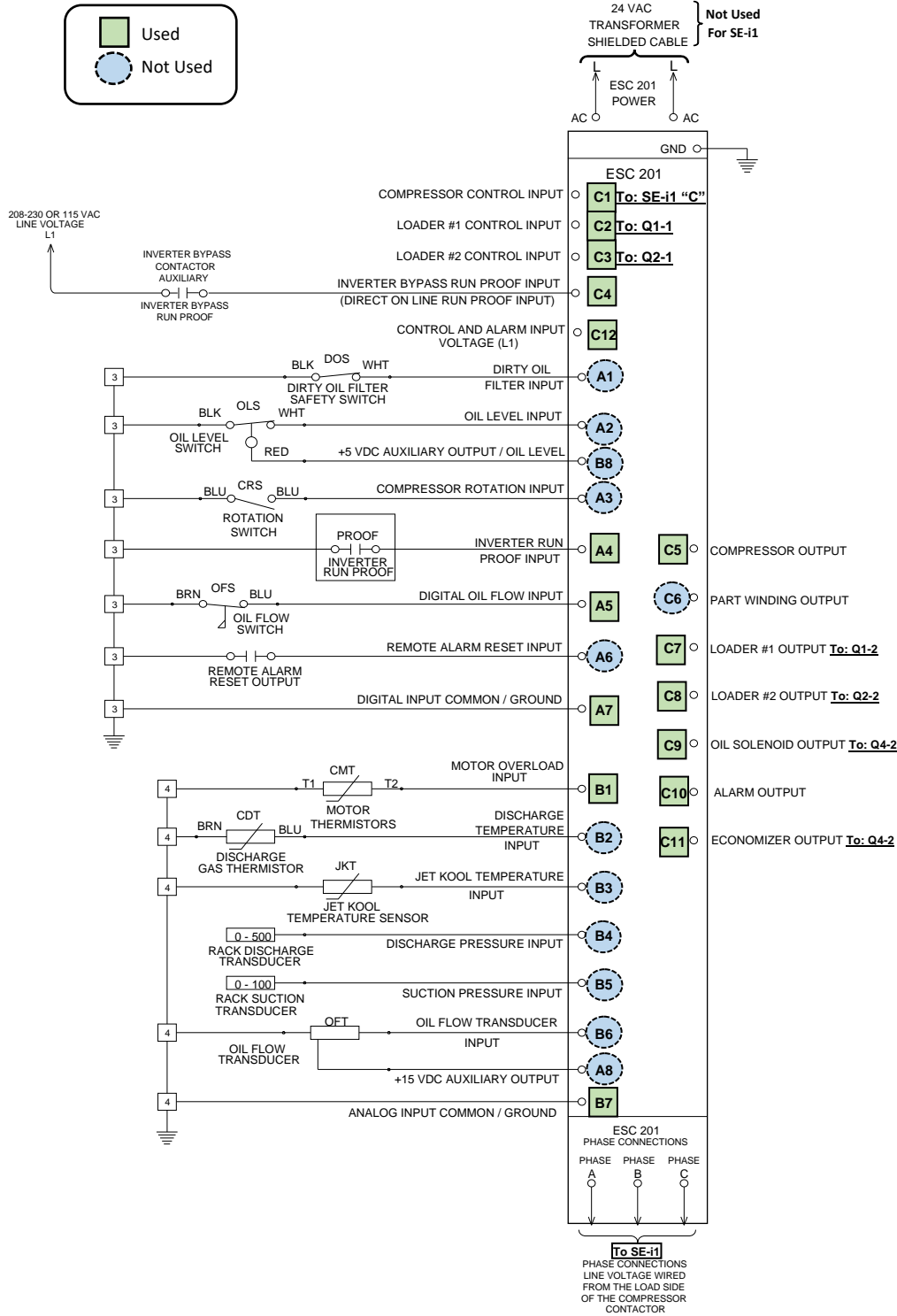

Main Components for Reference Included in 999-0620-01:

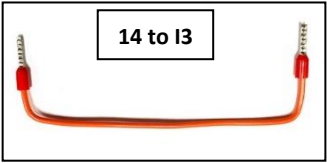
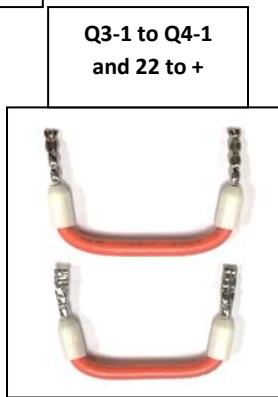
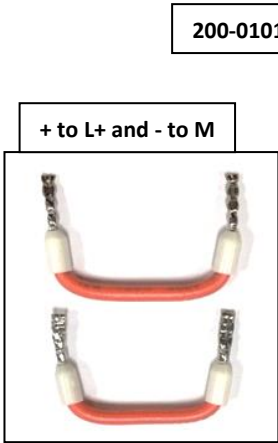
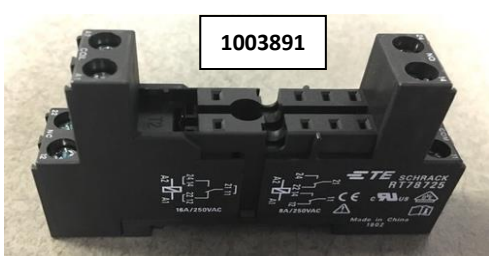

**NOT INCLUDED: Purchase Separate
BEST Tool: 344314-02
Required to Connect and Configure**

